

PLAN VIEW

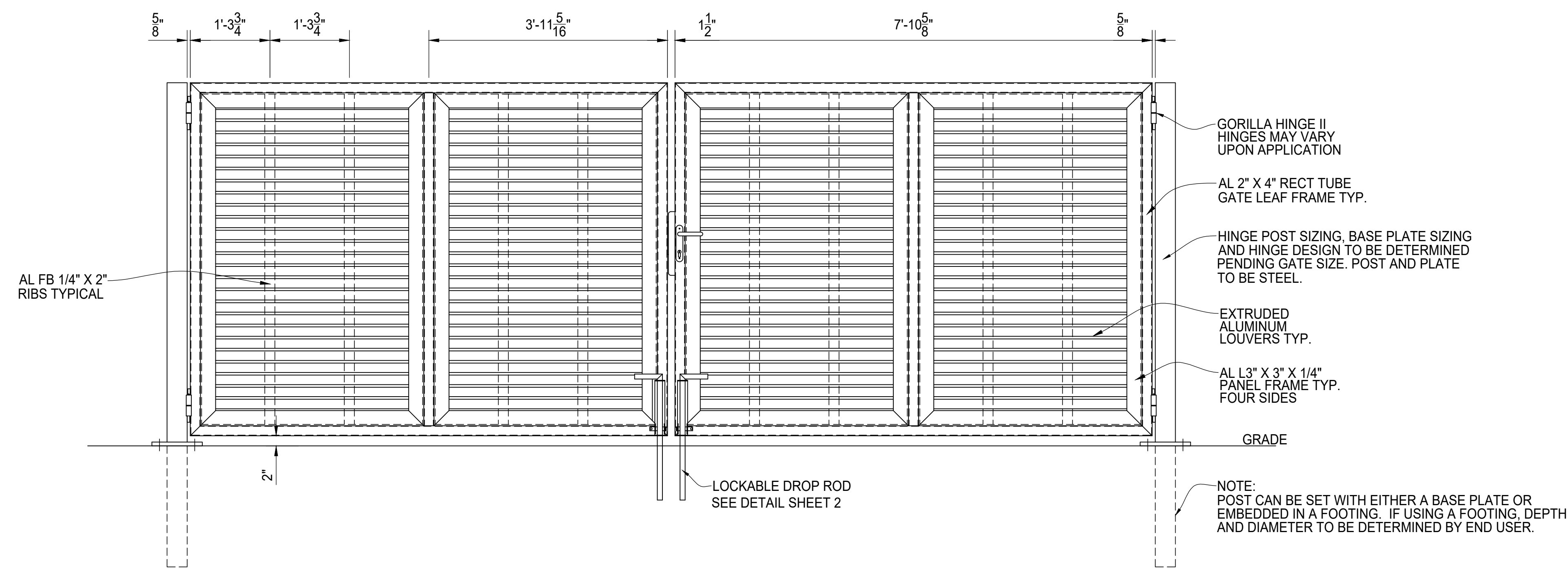

ELEVATION VIEW

DOUBLE DRIVE GATE ASSEMBLY
SEE DETAIL SHEET 2 FOR HINGE, LATCH AND DROP ROD

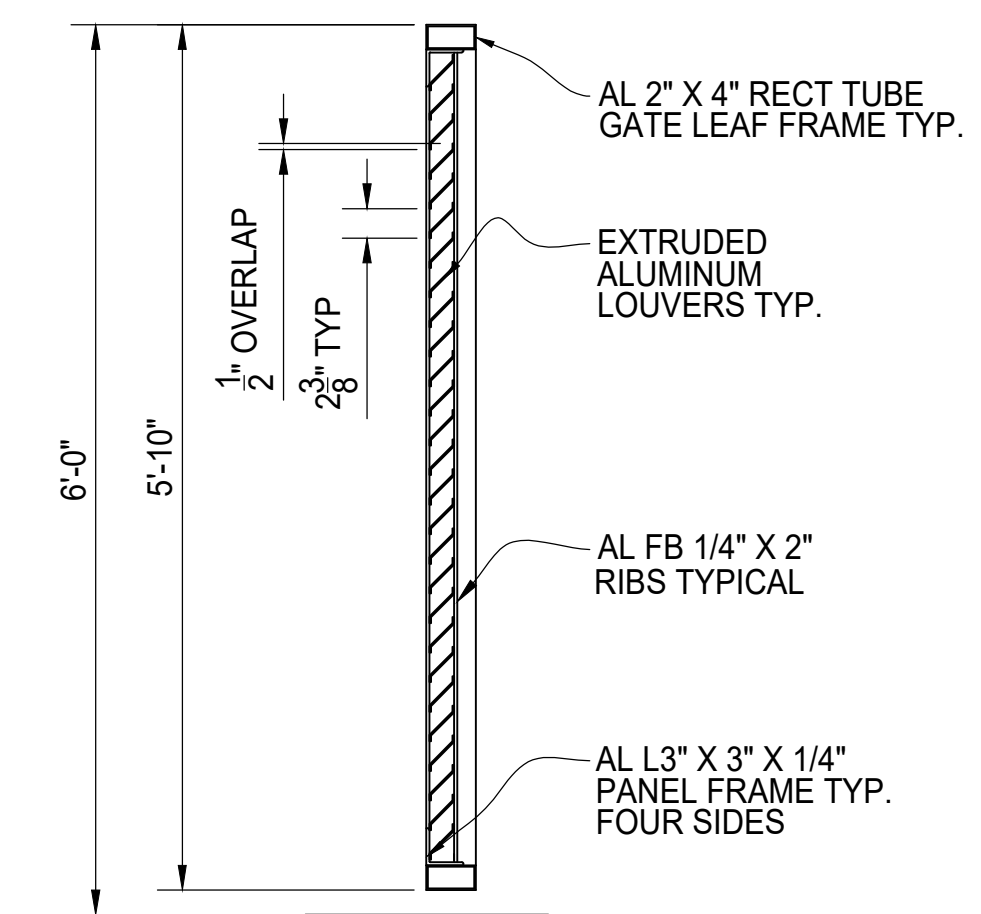

SIDE VIEW

GATE SECTION



ATLAS 6' TALL
HORIZONTAL LOUVER INFILL
16' WIDE DOUBLE DRIVE
GATE ELEVATION

AMERICAN FENCE PROJECT #	CLIENT PROJECT #
REFERENCE JOB #	
CHKD BY:	SCALE: N.T.S.
DRAWN BY: PB	DATE: 04/22/2020
REV:	SHEET # 01