

PLAN VIEW

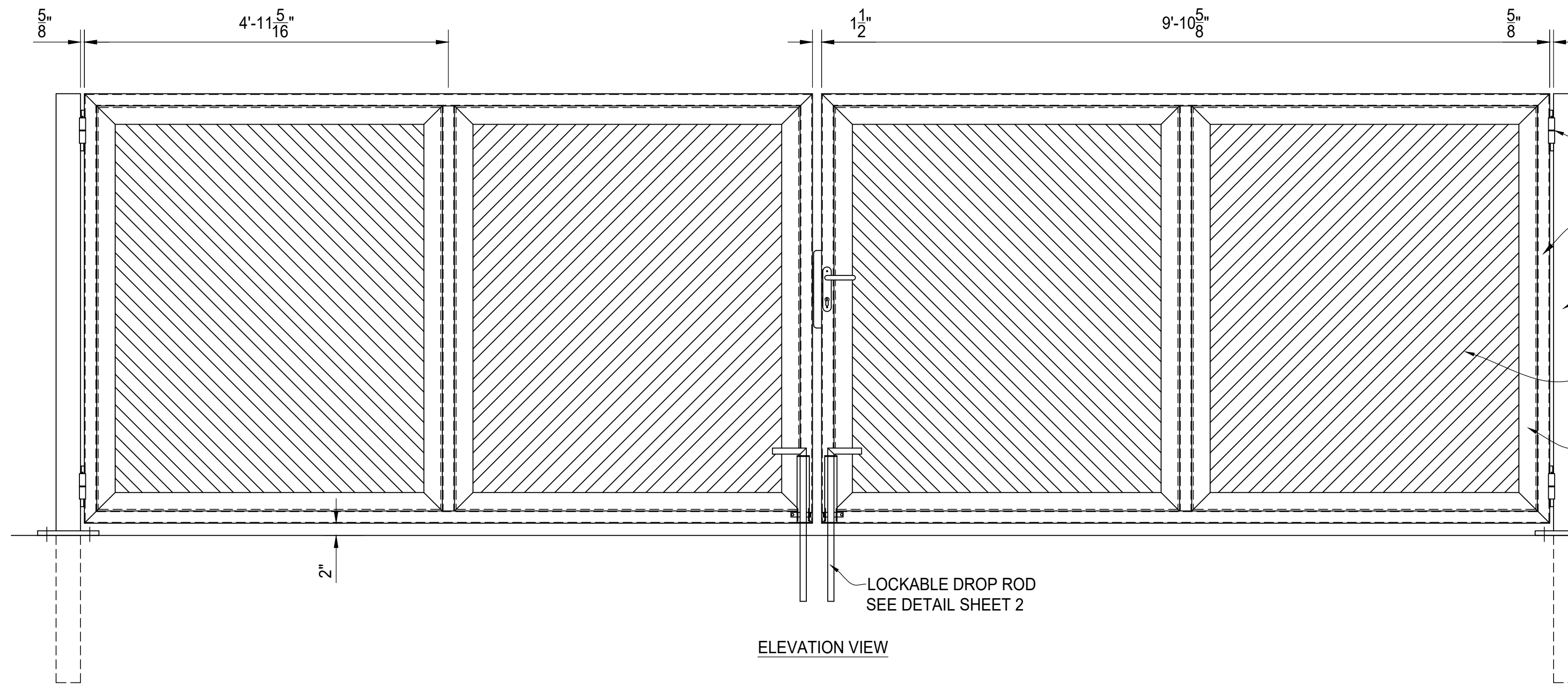

ELEVATION VIEW

DOUBLE DRIVE GATE ASSEMBLY
SEE DETAIL SHEET 2 FOR HINGE, LATCH AND DROP ROD

- GORILLA HINGE II
HINGES MAY VARY
UPON APPLICATION
- AL 2" X 4" RECT TUBE
GATE LEAF FRAME TYP.
- HINGE POST SIZING, BASE PLATE SIZING
AND HINGE DESIGN TO BE DETERMINED
PENDING GATE SIZE. POST AND PLATE
TO BE STEEL.
- ALUMINUM 2" X 1"
RECT. TUBE INFILL
1 1/2" ± AIR GAP
- AL L3" X 3" X 1/4"
PANEL FRAME TYP.
FOUR SIDES
- GRADE
- LOCKABLE DROP ROD
SEE DETAIL SHEET 2
- NOTE:
POST CAN BE SET WITH EITHER A BASE PLATE OR
EMBEDDED IN A FOOTING. IF USING A FOOTING, DEPTH
AND DIAMETER TO BE DETERMINED BY END USER.

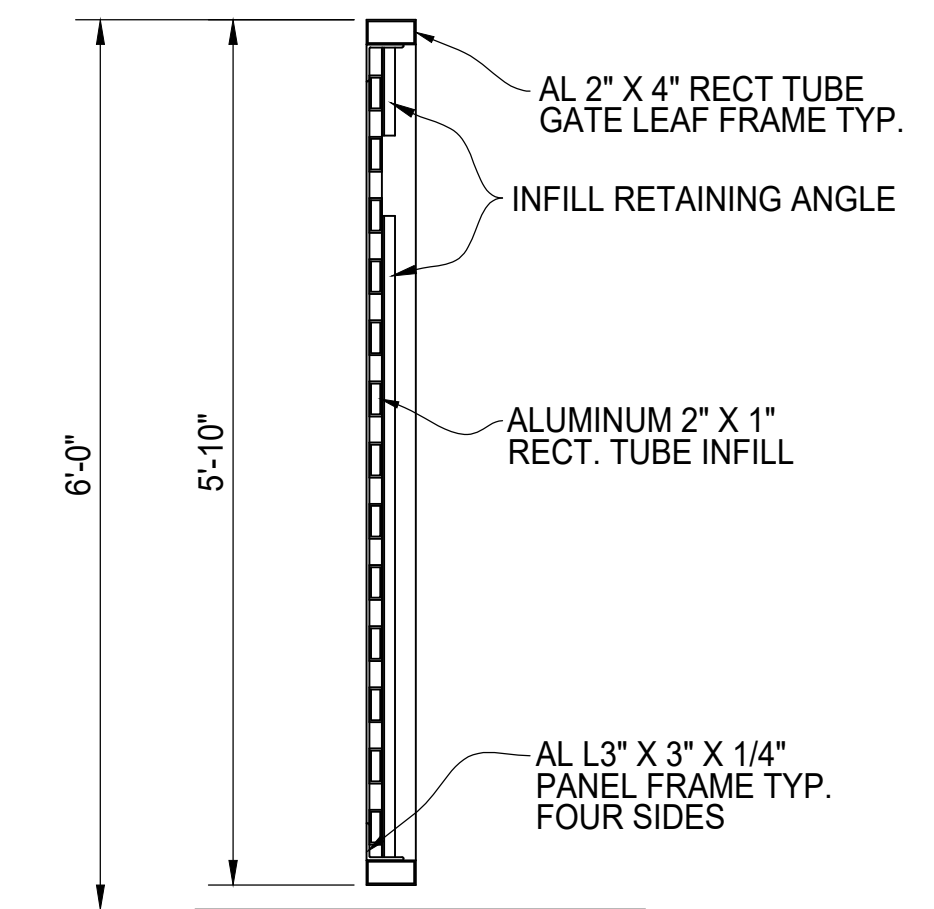

SIDE VIEW

GATE SECTION



ATLAS 6' TALL
DIAGONAL LOUVER INFILL
20' WIDE DOUBLE DRIVE
GATE ELEVATION

AMERICAN FENCE PROJECT #	CLIENT PROJECT #
REFERENCE JOB #	
CHKD BY:	SCALE: N.T.S. DRAWN: PB DATE: 04/22/2020 REV: SHEET # 01