



Company Information

PalmSHIELD

12330 Cary Circle
La Vista, NE 68128

For over fifty years, we have been designing, engineering and installing industrial equipment screen walls, industrial louvered screen, mechanical equipment enclosures and architectural screening systems. In addition to our custom louvered screen wall fabrication division, PalmSHIELD fabricates square welded and woven wire mesh screen, grating, and perforated metal screen. You can find our work from the base of the Grand Canyon to the midst of the Yellowstone Forest. PalmSHIELD is the ultimate architectural equipment screening.

Our fabrication division operates in a ninety thousand square foot facility that provides complete fabrication and coatings. Our team is led by a seasoned group of certified welders, coaters, project engineers and drafters. All we do is custom fabricate architectural products. Perforated metal, square woven and weld mesh, grating, industrial louvers and welded wire mesh screens are some of our top products.



We have installed other manufacturer's louvered, perforated metal and square mesh screen systems over the years. Our experience with these systems was not satisfactory. Our systems are designed to overcome all of our challenges in delivery, installation and sustainability. Having installed hundreds of screen wall systems and thousands of gates, we know a few things about what works and what does not.



What sets PalmSHIELD above all others is its fully framed manufactured panels and ease of installation. This rigid and robust frame protects the louvers, perforated metals, grating, cable railing and welded wire mesh during shipping, installation and for years to come. No assembly required. Our gates are manufactured first as standalone gates. We then fit our PalmSHIELD infill panels.

Our system is designed with the installers in mind. All of our panels and posts are factory aligned, then drilled and punched. All of our hardware is factory installed, removed and packaged. We factory install all the cabling for our cable railing. We are often not only the manufacturer but the installers as well. Our direct line of communication with the field gives us constant feedback and motivation to get it right.

PalmSHIELD has designed its own line of industrial hinges: the Gorilla Hinge. This hinge uses a half inch thick plate to mount to both the gate and gate post. The Gorilla hinge has a slight offset on the hinge plates to allow the gate to slightly close past full close. This intended design quirk was incorporated because we realize that not everything happens exactly like you want it to in the field. Sometimes, the gate posts are set an eighth to a sixteenth of an inch out of square. This is not noticeable at the post but a typical hinge would not allow the gate to come to a full close if the gate post was not set perfectly square. We empathize with these field irregularities and believe it is our responsibility to find a solution to offer our customers some flexibility.



PalmSHIELD louvered screening, walls, perforated metals, welded wire mesh and grating systems are perfect for providing excellent ventilation while keeping items out of sight from others. Using the industries' only picture frame design, each panel is rigid enough to stand on its own. Maintaining a consistent design throughout the system, PalmSHIELD can be configured as a series of screens, grills, swing gates and even sliding gates.

PalmSHIELD is custom fabricated to each application, allowing end users to select the amount of visibility and air flow by varying louver spacing or degree of perforation. Louvers may be placed vertically, horizontally or even diagonally



CHARLEMAGNE Perforated Aluminum Product Data

With a wide variety of hole sizes, percentage of open area, high strength-to-weight ratio and aesthetically pleasing, PalmSHIELD's CHARLEMAGNE architectural screening includes perforated metal sheet for endless applications. CHARLEMAGNE perforated infill is perfect when you want to show a silhouette of what is behind your screen but nothing more. You can obscure what is behind the fence or screen but you can still see others moving about. CHARLEMAGNE architectural perforated screening also provides exceptional wind flow as hole sizes and on-centers can vary.



Perforated screening is available in the following patterns:

- Round hole
- Square hole
- Hexagonal hole
- Slotted hole
- Decorative hole
- Custom patterns based on your CAD or PDF





CHARLEMAGNE Perforated Aluminum Materials Technical Data

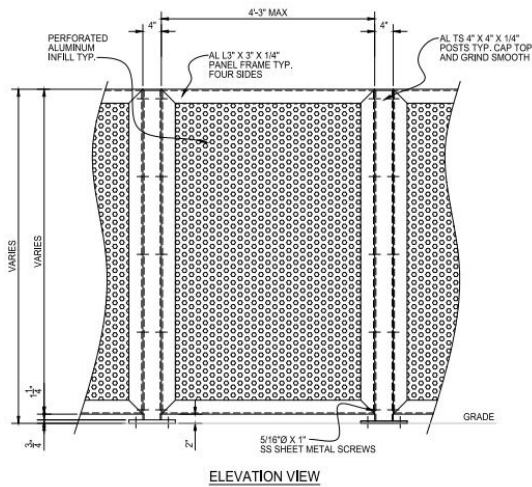

TYPICAL PERFORATED INFILL PANEL DETAIL
1/8" THICK ALUMINUM W/ 1"Ø HOLES ON 1 1/4" CENTERS (58% OPEN)

PalmSHIELD complies to the following standards:

- A. ASTM B 209 – Standard Specification for Aluminum and Aluminum-Alloy Sheet and Plate.
- B. ASTM B 221 – Standard Specification for Aluminum and Aluminum-Alloy Extruded Bars, Rods, Wire, Profiles and Tubes.
- C. ASTM D3363 – Standard Test Method for Film Hardness by Pencil Test.
- D. ASTM D2794 – Standard Test Method for Resistance of Organic Coatings to the Effects of Rapid Deformation.
- E. ASTM B117 – Standard Practice for Operating Salt Spray Apparatus.
- F. ASTM D822 – Standard Practice for Filtered Open- Flame Carbon-Arc Exposures of Paint and Related Coatings.
- G. AWS D1.2 Structural Welding Code
- H. Aluminum. Extruded Aluminum: ASTM B

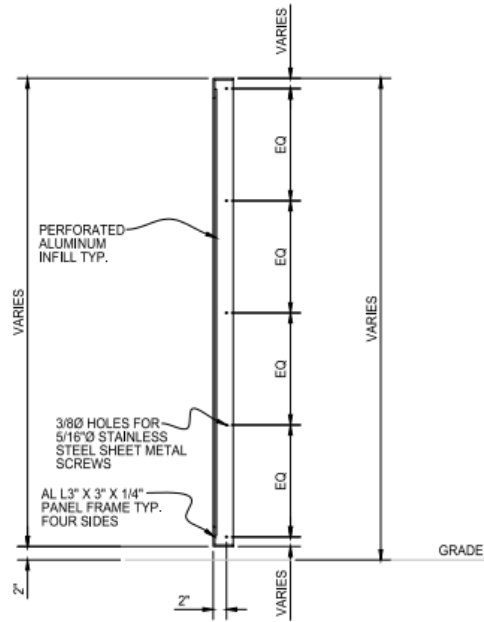

TYPICAL PANEL SECTION

1/8" THICK ALUMINUM W/ 1"Ø HOLES ON 1 1/4" CENTERS (58% OPEN)

221, Alloy 6063 – Temper T-6.

- I. Sheet Aluminum: ASTM B211, Alloy 6063 – Temper T6.
- J. PalmSHIELD incorporates the following materials and design characteristics into our CHARLEMAGNE Perforated Aluminum:

Panel Description:

1. Panel Height: Varies
2. Perforated Panel Width: Not to exceed 60".
3. Perforated panel perforations as shown on the drawing.
4. Perforated fencing system consisting of horizontal, fixed perforated, modular fence panels fabricated with extruded aluminum framing bars and supported by extruded aluminum fence posts.
5. Vertical Framework: 3 inch x 3 inch x 1/4 inch aluminum angle. Framework supporting the square mesh sheet shall be solid welded and mitered.
6. Horizontal Top Cap: 3 inch x 3 inch x 1/4 inch aluminum top cap.
7. Horizontal Bottom Cap: 3 inch x 3 inch x 1/4 inch angle bottom cap
8. Cross Bar: 2 inch x 1/8 inch aluminum flat bar.

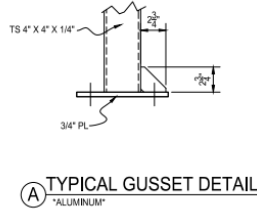
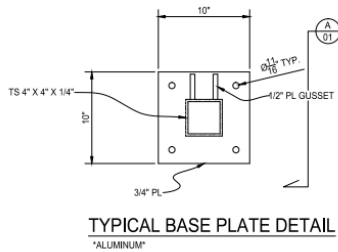

Fence Posts:

1. Panel posts shall be 4 inch square by 1/4 inch minimum extruded tubular aluminum sections with solid aluminum caps. Length as specified on the contract drawings.
2. On center post spacing shall be as specified by manufacturer.
3. All fence posts to be plated with 10" x 10" x 3/4" aluminum plates with four 3/4" hole for anchors.

Fittings and accessories: All fittings and accessories shall be stainless steel and sized as specified by the fence manufacturer. Fence panels to be attached to posts with 1/4" x 1" stainless steel screws. Panels and posts are predrilled to support level installation.

Anchor Bolts: Anchor bolts shall be adequate to support loads based on screening height, exposures and loading.

Gates: Swing to exterior of enclosure, size as shown on contract drawings.

1. Perforated panel style and appearance shall be identical to fence panels.
2. Gate hinges to be Gorilla barrel hinge with 3/4" rod, ball bearing, and grease zert. Hinge plate to be 1/2" thick plates offset to create a 5/8" gap. Standard hardware as required by the gate manufacturer for complete functional operation. Hinges to be bolted to gate frame and field welded to steel gate posts.

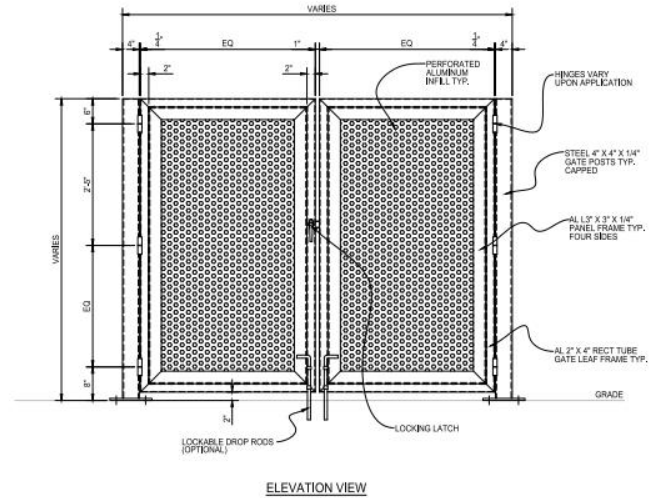
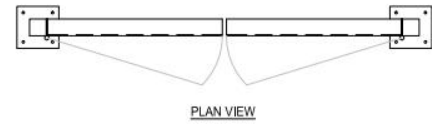

3. Gate latch to be internal lock with exterior grab handles. Lock may be keyed and rekeyed. Lock is accessible from both sides of gate.
4. Welded frame, size as shown on the contract drawings, extruded aluminum tubing with aluminum perforated panels to match fencing material.
5. Drop rods to be 1" schedule 40 pipe and

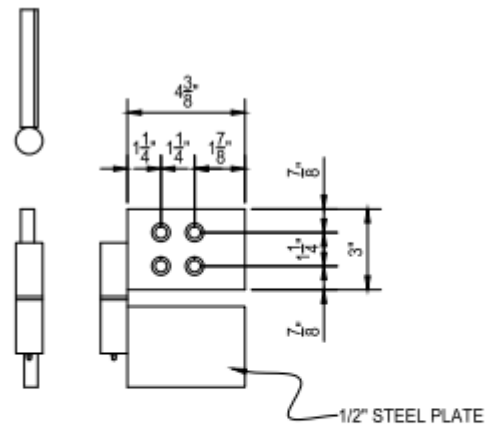

HINGE DETAIL

ZERK END IS FEMALE
 FIELD WELD TO POST
 MALE END ATTACHES TO GATE
 MALE DOWN FOR GATE LIFT OFF
 A "STOP" CAN BE WELDED TO THE GATE POST
 ABOVE THE HINGE TO PREVENT LIFT OFF

through bolted to gate frame.

6. Hardware: Size and type as determined by the manufacturer. Provide three hinges per leaf.
 - a. Provide 1 inch diameter center cane bolt assembly and strike, each door.
 - b. Provide PalmSHIELD exclusive internal locking device accessible from both sides of the gate and keyed.

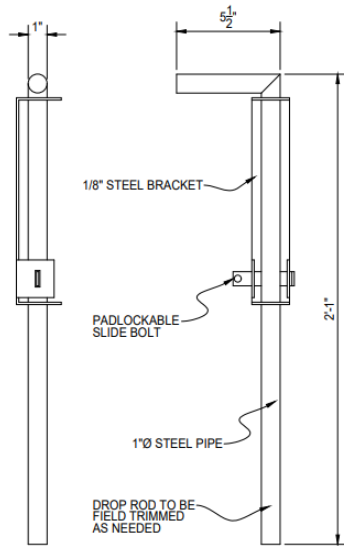

DROP ROD DETAIL

7. Gate shall have welded frame fabricated from extruded aluminum tubing with aluminum fixed perforated panels to match fencing material. Frame configurations shall be as indicated on the contract drawings.
8. Gate posts shall be as determined by manufacture. Gate posts to be specified to support gates.



CHARLEMAGNE Perforated

Aluminum Coating

Standards Technical Data

PROCESS

PalmSHIELD powder coating process and standards are based on a three-step process.

Step 1. Removal of oil, dirt, lubrication greases, metal oxides, welding scale etc. is essential prior to the powder coating process. PalmSHIELD utilizes both phosphates spray application and sweep blasting the surface. The use of a phosphate spray consist of degreasing, etching, de-smutting, various rinses and the final phosphating of the substrate. The pre-treatment process both cleans and improves bonding of the powder to the metal. Blast media and blasting abrasives are used to provide surface texturing and preparation, etching, finishing, and degreasing.

Step 2. Applying the powder. The most common way of applying the powder coating to metal objects is to spray the powder using an electrostatic gun. The gun imparts a negative charge to the powder, which is then sprayed towards the grounded object by mechanical or compressed air spraying and then accelerated toward the workpiece by the powerful electrostatic charge.

Step 3. Curing the powder. When a thermosetting powder is exposed to elevated temperature, it begins to melt, flows out, and then chemically reacts to form a higher

Cured Film Properties:

PCI Powder Smoothness Rating 8-9 (high gloss)
Specific Gravity (ASTM D792) 1.2 to 1.8
Adhesion (ASTM D3359) 5B (100%)
Gloss (ASTM D523) 30-99
Pencil Hardness (ASTM D3363) H-4H
Impact (ASTM D2794) 160 - 240+ inch lbs.
Flexibility (ASTM D522) 1/8 inch - No fracturing
Humidity (ASTM D2247) 1,000+ hours
Salt Spray (ASTM B117) 1,000+ hour

molecular weight [polymer](#) in a network-like structure.

STANDARDS

PalmSHIELD meets and exceeds the following standards for applying our factory finish to aluminum fence panels, posts and gates to receive a polyester powder coating.

Polyester powder coating: Electrostatically applied colored polyester powder coating heat cured to chemically bond finish to metal substrate.

Minimum hardness measured in accordance with ASTM D3363 2H.

Direct impact resistance tested in accordance with ASTM D2794. Withstand 160 inch-pounds.

Salt spray resistance tested in accordance with ASTM B117: No undercutting, rusting, or blistering after 500 hours in 5 percent saltspray at 95° F and 95% relative humidity after 1,000 hours, less than 3/16 inches undercutting.

Weatherability tested in accordance with ASTM D822: No film failure and 88 percent gloss retention after 1 year exposure in South Florida with test panels tilted 45°.

PRODUCT

PalmSHIELD uses only the highest quality products. Using PPG, Peridium TGIC Polyester powder coatings offering excellent application and performance characteristics. Peridium's tightly controlled particle size distribution provides extremely good first pass transfer efficiencies and edge coverage along with the smoothest film available. Long term exterior durability, high performance mechanical properties and overbake resistance are also common characteristics of these premium TGIC polyester coating



CHARLEMAGNE Perforated Aluminum Installation Standards Technical Data

PalmSHIELD prides ourselves on having a reputation of being the most user-friendly screening systems to install. We have been working directly with installers for over a decade to improve our overall installation.

At the onset of your installation, you can look forward to:

- a. All of our panels and posts are predrilled and verified post-fabrication for alignment.
- b. Two common fasteners are used to attach the panels to the posts. Below is a simple description and photo identification. No fussing or fumbling through a wide variety of hardware.
- c. Our hinges are pre-mounted to the gate frames. The remaining half is packaged to be field welded to the steel gate post. You may request that we fully install your hinges if you are sure of site conditions.
- d. Our drop rods are all pre-mounted to the gate frames.
- e. Our internal locking devices are all pre-installed on the gate frames.
- f. With level PalmSHIELD systems, everything is self-aligning. Align the panel to the top of the posts and everything will line up.
- g. You will receive a system layout drawing that numbers all the posts and panels. The posts and panels are all labeled on the bottoms to coincide with the drawing.

Important items to review at the start of the installation

- h. Every PalmSHIELD installation was initiated with a fabrication drawing. This drawing is the basis for your installation. Please follow this drawing to the letter as there is no flexibility in the dimensions.
- i. Unless stated otherwise on your fabrication drawing, PalmSHIELD systems are to be installed level. As most systems are installed outdoors, most exterior paving is not level. If your surface is not level, you will need to verify and plan accordingly.
- j. Review the swing of your gate. Will it interfere with any other surface like raised equipment pads and curbing?

Hardware included with your PalmSHIELD system

1. 3/8" x 1 1/4" stainless steel cap bolt. This is for installing panels to steel posts. The steel posts are already tapped accordingly.
2. 5/6" x 1" stainless steel sheet metal screw. This is used for connecting the panels to the aluminum posts. All holes are pre-drilled.
3. Ball bearing. These are packaged separately. One ball bearing per hinge.
4. Drop rods. These are pre-installed on the gates.
5. Locking devices. These are pre-installed on the gates.
6. Hinges. Half of the hinge is pre-installed on the gate post. The other half is packaged to be field welded unless instructed otherwise.
7. Oil. This oil is to be placed on the tip of each sheet metal screw



Sheet Metal Screw

Cap bolt

Hardware not included.

- k. Post anchors are not included. Based on 4000 psi concrete, you may consider 5/8" x 6" epoxy anchors or 5/8" x 5 1/2" wedge anchors. PalmSHIELD is not responsible for determining anchor type or installations. This should be determined by qualified individual based on site conditions.
- l. Padlocks for locking devices.

Pre-installation Preparation

1. Using some form of marking chalk or tape, layout your system in accordance with your included fabrication drawings. If you do not have these drawings, please inquire with PalmSHIELD for a copy.
2. Layout each run from outside of post to outside of post.
3. Layout gate openings from inside of post to inside of post.
4. Layout the entire system prior to starting to insure it fits your space as you intended.
5. If concerned about changing elevations, identify the highest elevation on your site where the system is to be installed. This may be your benchmark for setting

your posts. All of your posts will have to be installed to this elevation. A couple hints to make this easy.

- a. Start at the highest elevation and level each panel as you go. OR
 - b. Run a string line along the installation. Set it flush at the point of highest elevation and then level it over the balance of the installation. OR
 - c. Use a site level and determine the change in elevation at each post.
 - d. As the elevation drops, you will have to either shim under your posts or install leveling nuts to your anchors.
6. If changing elevations are not an issue, start your PalmSHIELD system at a permanent structure such as building or wall. It is to start here and work out into space where you do not have to be concerned about ending gaps.

Installation Steps

1. Verify your panels and posts compared to your fabrication drawings to assure every panel and posts was accurately fabricated. If you identify an error, please contact us as soon as possible and prior to any installation. PalmSHIELD will be responsible for fabrication errors but not installation costs as a result of these errors.
2. It is best to install your PalmSHIELD system in a post, panel, post, panel order. It is not advised to try to set all of the posts first and then come back and install the panels.
3. Using the post base plate template provided with your order,
 - a. use the template to align the first post to your site markings.
 - b. Make sure the post base plate runs parallel to the run and it is not twisted.
 - c. Mark the center of the anchor holes.
4. Set your anchors.
5. Select your first post based on the drawing. Posts are labeled in accordance with the drawing. You should verify if it is a corner, end, or gate post from the fabrication drawing. This can be identified based on the holes drilled in the post for attachment of the panels and gates.
6. Set your first post. Make sure your post is plumb in all directions.
7. Select your first panel. You will need to identify it based on your fabrication drawings. These are numbered in accordance with the drawings on the bottom of the panels.
8. Align the panel to the post. Make sure the louvers are facing in the correct direction and the panel is not upside down. Some louvers are installed with restricting visibility from looking down so check your fabrication drawings for louver alignment.
9. Align the top of panel to top of post so that it is flush. Use bar clamps to attach panel to post.
10. Use wood blocking to shim under panel to hold alignment and level.
11. Place one drop of oil on the tip of each sheet metal screw prior to installing. This will provide added lubrication and assist in threading.
12. If necessary, use a universal joint, install the stainless steel machine screws or bolts through the panels and into the posts. Do not over tighten. Aluminum is a soft metal. The stainless steel sheet metal screws will self-thread into the holes. However, if you over tighten or torque, you will quickly strip the aluminum. Use a screw gun with an adjustable clutch to better assure you do not strip.
13. Once the first panel is installed to the first post, select your second post based on your fabrication drawing. Repeat steps 5 – 9.
14. At gate opening, be sure to install gate posts as shown on the drawings. Be sure your openings (inside to inside of post) are accurate.
15. Gate installations will vary based on site conditions. You should consider the swing of the gate relative to the grade that it sweeps over and make sure that there is plenty of clearance. Look for steep rising slopes, adjoining equipment pads with a higher elevation and curbing.
16. Once you have determined the elevation of your gate, weld the remaining half of the gate hinge to the post. Align the gate hinge so the back of the barrel where it meets the plate is 3/8" in front of the post. In other words, there is a 3/8" gap between the barrel and the gate post.
17. Close the gate to the appropriate location. Lower the drop rod and mark the socket location. Repeat for the open position if necessary. For drop rod sockets, we recommend a 1 1/2" hammer drill or core bit. You may have to trim the drop rod.
18. The internal locking device should not require any further installation. The keys are located in the hardware package.
19. PalmSHIELD includes touch-up paint. Closely inspect your installation for any chips or scratches. Hold the can 6" to 8" from the area to be painted and sweep across it until entirely covered. The paint will blend with the powder coated surface.

Tools Needed.

- m. At least six bar clamps with minimum of six inch jaw.
- n. Socket set
- o. Set of open end wrenches
- p. 1" universal joint (knuckled socket).
- q. Screw gun with clutch adjustment.
- r. Hammer drill bits for anchors. To be determined by contractor.

- s. 1 ½" hammer drill or core bit for drop rods (if required).
- t. Hammer drill bits.
- u. Level
- v. Marking tape or paint
- w. String line.
- x. Rubber mallet
- y. Welder (if required for gate installations on steel posts)



CHARLEMAGNE Perforated Aluminum Continued Product Care Technical Data

PalmSHIELD CHARLEMAGNE Perforated Aluminum should not further maintenance and care beyond customers best intentions to clean the product.

In the event you do wish to wash the product, we recommend using a high quality care wash soap or nonabrasive dish wash soap.

Using a nonabrasive wash mitt or sponge, gently scrub the product back and forth to remove any dust or debris. Once finished, gently hose off the remaining soap.

Do not use a power washer, abrasive tools, or scrapers.

