

PLAN VIEW

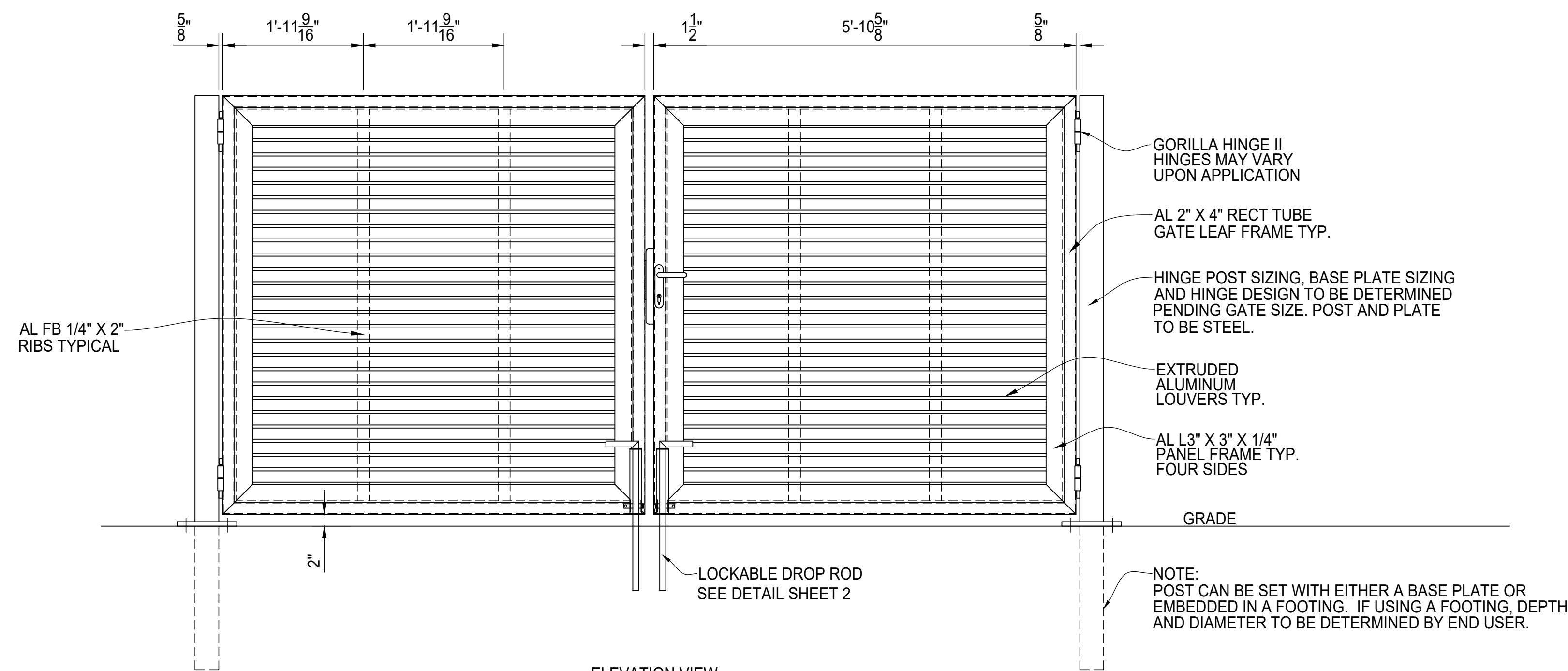

ELEVATION VIEW

DOUBLE DRIVE GATE ASSEMBLY
SEE DETAIL SHEET 2 FOR HINGE, LATCH AND DROP ROD

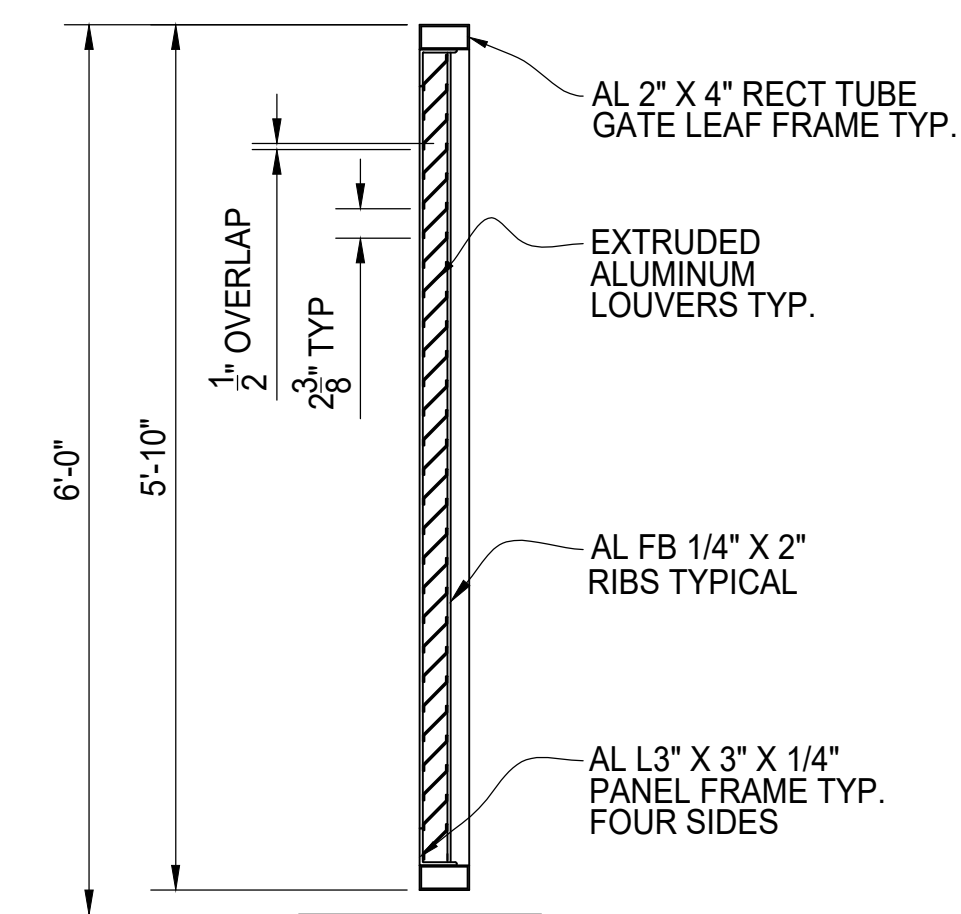

SIDE VIEW

GATE SECTION



MAXIMUS 6' TALL
HORIZONTAL LOUVER INFILL
12' WIDE DOUBLE DRIVE
GATE ELEVATION